

Simple Touch™ Cellular Shade Installation Instruction

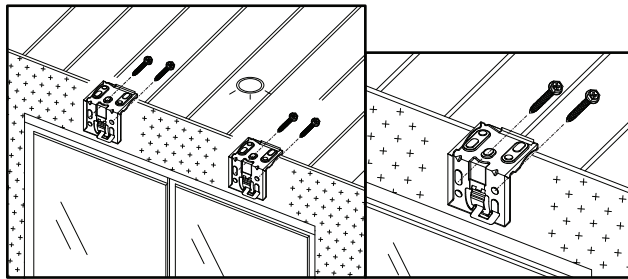

Fig(1-1)

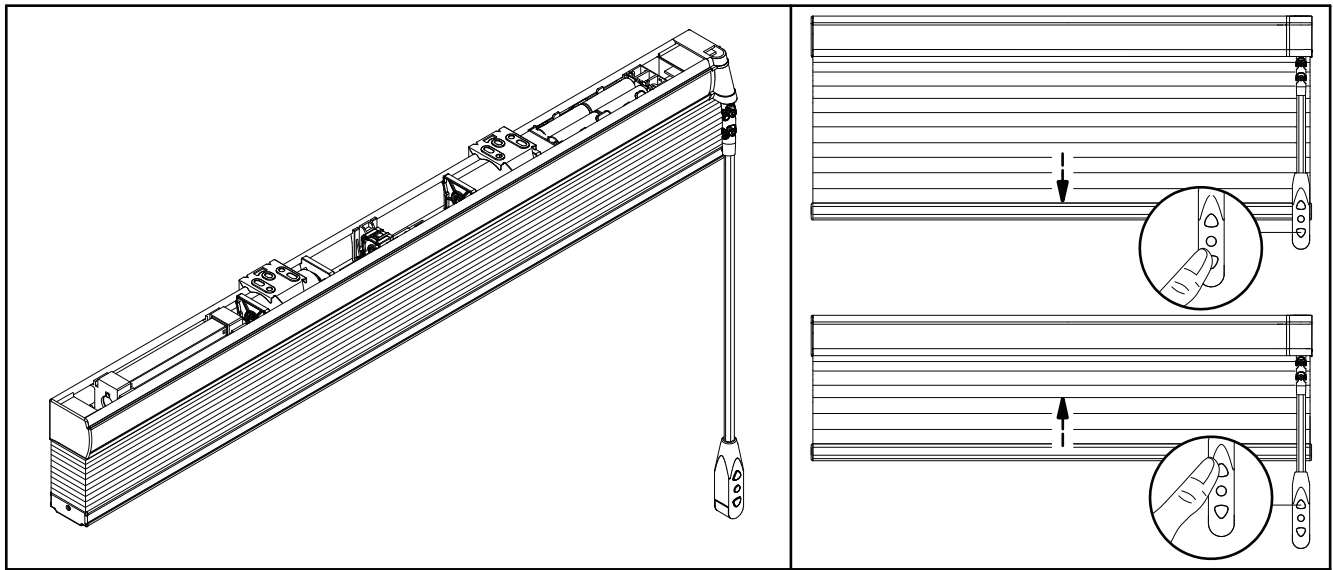
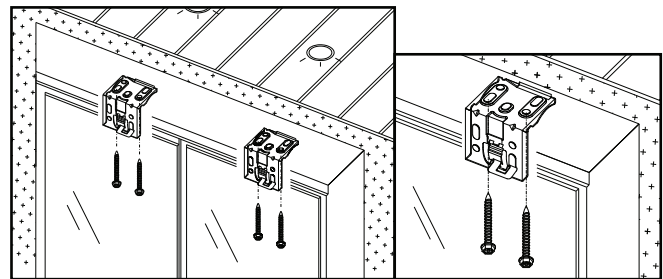

Fig(1-2)

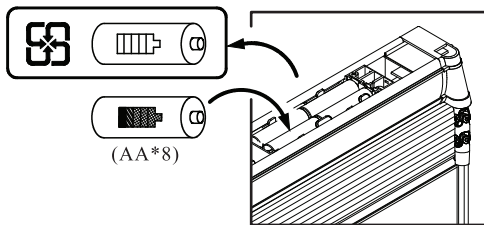

Fig(2)

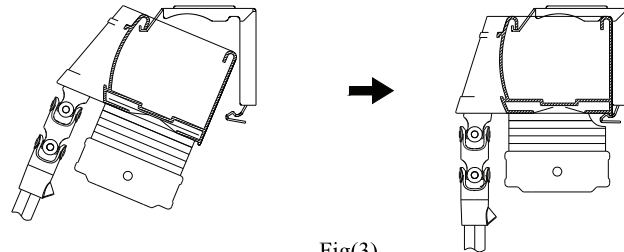

Fig(3)

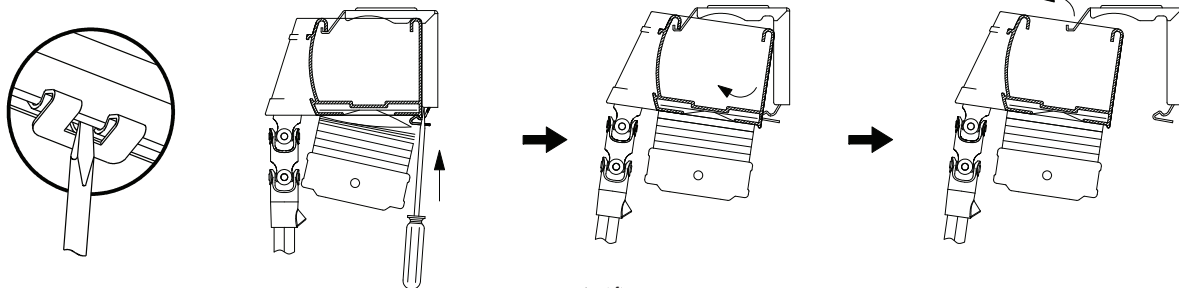

Fig(4)

1. Find location on the headrail where brackets go on the shade.
2. Mark the bracket location on the window fixture.
3. Fasten the brackets on the fixture. (Fig 1)
4. Put 8 AA batteries inside the battery box. (Fig 2)
5. Mount the shade onto the brackets. (Fig 3)
6. To change the batteries, remove the shade from the brackets. (Fig 4)
7. Replace with new batteries (do not mix new batteries with used batteries. Mount the shade.

Simple Touch™ Programming Guide:

Set Clear :



Press 3 Buttons at the same time.

Long  B ~

Setting OK.

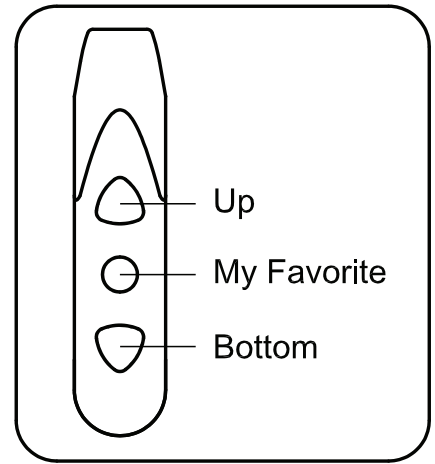

Set Upper Limit :

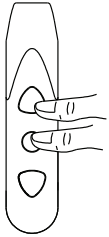

Press Up to move the shade to upper limit.

Press Up & My Favorite at the same time for 5 seconds.

 B - - -

Setting upper limit complete.

Set Bottom Limit :



Press Bottom to move the shade to bottom limit.

Press Bottom & My Favorite at the same time for 5 seconds.

 B - - -

Setting bottom limit complete.

Set My Favorite Position:

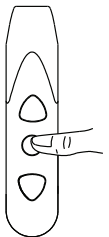

Operate the shade to your favorite position.

First press My Favorite for 5 seconds.  B -

Second press My Favorite again at 3 seconds interval.  B - - -

Setting My Favorite OK.

- Before setting the shades , shades can only operate by pressing the button.
- Before setting the shades , My Favorite-Button can only stop.

How to operate a SIMPLE TOUCH™ shade:

- After setting the shades , press Up or Bottom button for 1.5 seconds , the shades will operate without finger pressing the button.
- After setting the shades , press My Favorite button for 1 second , the shades will operate to the favorite position.
- After setting the shades , press any button to stop.