

SIMPLY MOTORIZED CELLULAR SHADE INSTALLATION & USER GUIDE

1 WHAT ARE INCLUDED

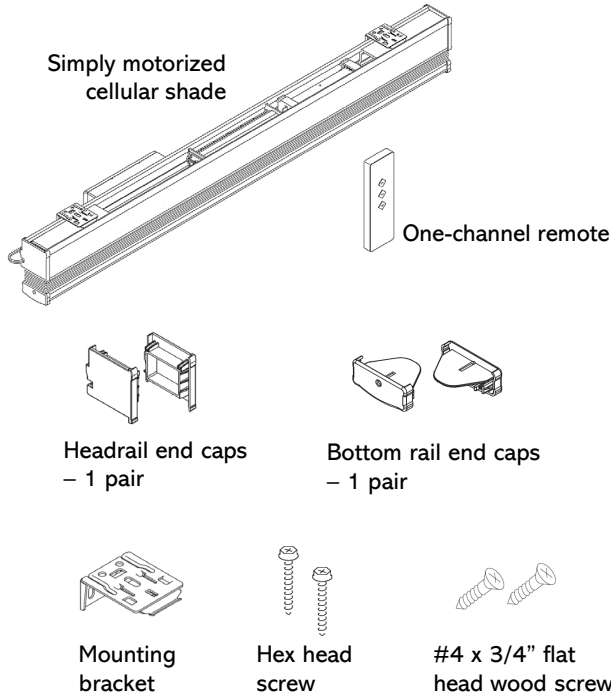

Quantity of mounting brackets and screws

Shade width	Bracket	Hex head screw	Flat head screw
Width ≤ 38"	2	4	4
Width > 38"	3	6	6

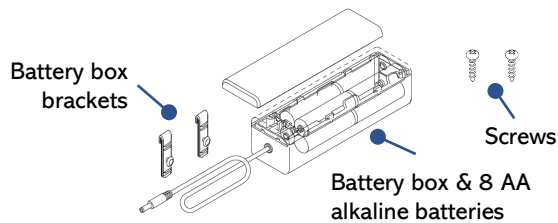

Replace the batteries when the shade is not responsive or when the moving is slower than usual.

Replacing the batteries doesn't affect the setting of the shades.

2 TOOLS AND PARTS YOU MAY NEED (not included)

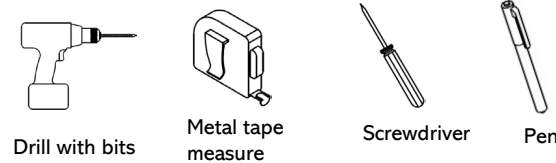

3 INSTALL THE BRACKETS

- BRACKETS MUST BE LOCATED OVER THE COMPONENTS.** See the example image below.

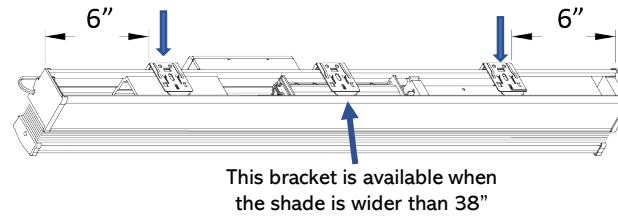

- Install the bracket 6" away from the end on each side.
- For the shade wider than 38", install the 3rd bracket at the center of the shade.

FOR INSIDE MOUNT - Install the bracket with the hole at top center by using the hex head screw or with two holes at the top rear side by using #4 x 3/4" flat head wood screws.

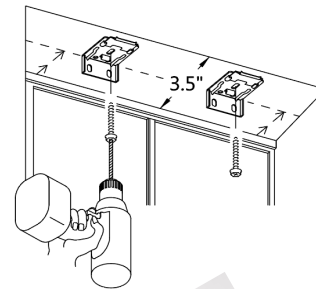

Use flat head screws for the top rear side holes.

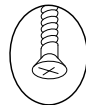

Use the hex head screw for the top center hole.



FOR OUTSIDE MOUNT – install the bracket with two holes at the back side with the hex head screws.

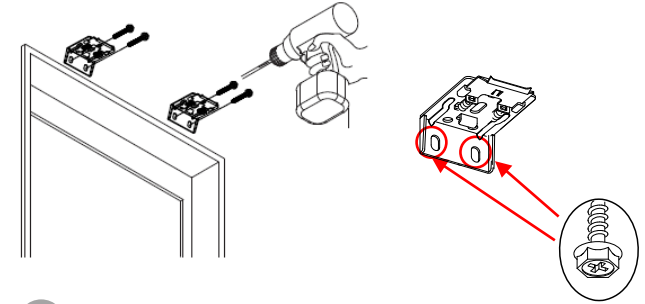

4 MOUNT THE BATTERY BOX

- Connect the battery box to the motor. Attach the headrail and bottom rail end caps to the shade.

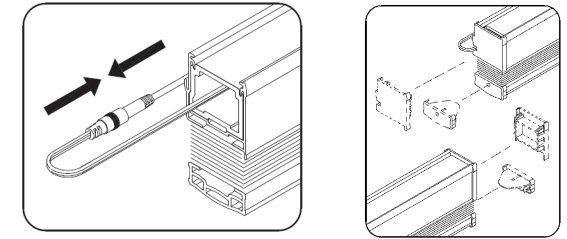

- The battery box can be hooked behind the headrail. The flush mount space is 3.5"D.

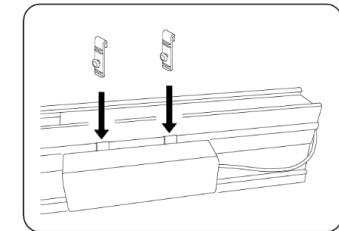

- Or mount the battery box to the wall or window frame at the location that is away from the child's reach.

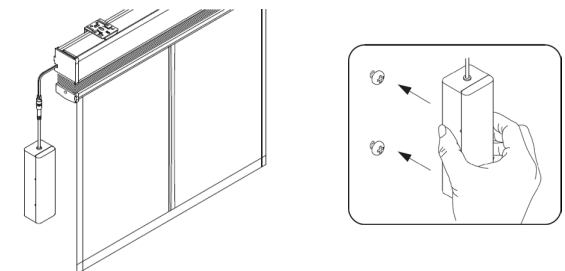

NOTE

- Optional power source of the rechargeable battery pack is available (sold separately).

5 ATTACH THE SHADE TO THE BRACKETS

- Position the headrail with the front lip resting on the top hooks of all the brackets.
- Push the bottom of headrail firmly upward and toward the window until the groove at the bottom of the headrail snaps into place.

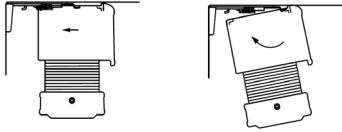

HOW TO REMOVE THE SHADE FROM THE BRACKETS

- Use the remote to raise the shade completely. Push the headrail toward to the wall.
- Tilt the backside of the headrail down
- Once the back of the headrail clears the brackets, pull the headrail off the front of brackets.

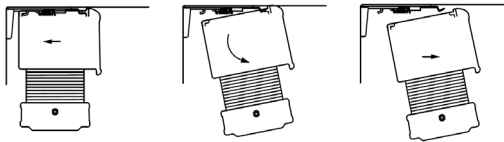

6 INSTALL THE REMOTE

- Install the small white square hook with the included screw to the wall at a location that is away from child's reach.

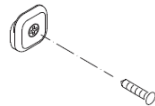

Back side of the remote

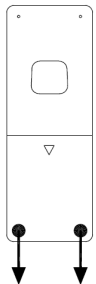

Press and push down to remove the cover.

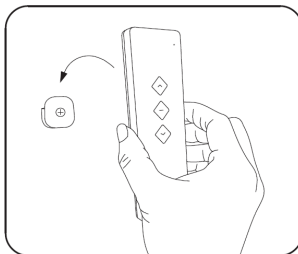

Replace the batteries of the remote when it is not responsive or when the controlling distance becomes shorter.

This Simply motorized shade is already connected to the remote and programmed with the TOP and BOTTOM Limits.

Adjust the BOTTOM limit when needed. See the instructions on the programming guide.

7 OPERATE THE MOTORIZED SHADE

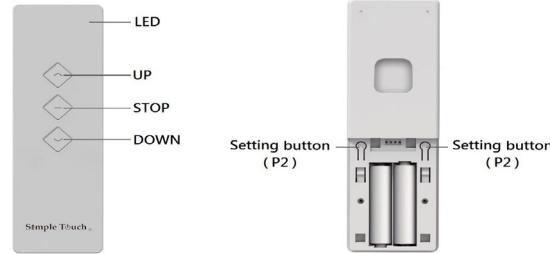

OPERATION

- Click the **UP** or **DOWN** button to raise or lower the shade.
- Click the **STOP** button to stop the moving of the shade.
- You can control the shade to your desired height by setting up **MY FAVORITE POSITION**. See the instructions below (the My Favorite position is an optional setup).

SET UP "MY FAVORITE POSITION"

- | | |
|--------|--|
| Step 1 | Adjust the bottom rail to your favorite height by clicking the DOWN or UP buttons. |
| Step 2 | Click one of the P2 buttons. The shade jogs once. |
| Step 3 | Click the STOP button once. The shade jogs once. |
| Step 4 | Click the STOP button again. The shade jogs twice. |

Set up My Favorite Position is done.

AFTER SET UP MY FAVORITE POSITION

- Press the **STOP** button until the shade moves.
- The bottom rail will travel to **MY FAVORITE** position.

REMOVE "MY FAVORITE POSITION"

- | | |
|--------|--|
| Step 1 | Click one of the P2 buttons. The shade jogs once. |
| Step 2 | Click the STOP button once. The shade jogs once. |
| Step 3 | Click the STOP button again. The shade jogs once. |

Remove My Favorite Position is done.

NOTE

- Optional control of the 15-channel remote is available (sold separately).

8 CARE AND CLEAN

- Wipe the shade periodically with a soft dust cloth or dusting mitt, or vacuum with a lowest speed.

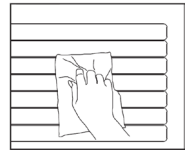

NOTES

- The motorized shade and remote are not water resistant and could be damaged by water or moisture.
- Do not operate/ clean it with wet hands.
- Indoor use only.
- The remote could be damaged when dropped or hit.
- Changing the batteries or charging the rechargeable battery pack won't change the programming setting.
- The warranty does not cover damage caused by improper cleaning or operating.

FOR INDOOR USE ONLY

FC FCC ID
#2AWSE-STP053

This motorized shade has been tested and found to complete with the limits for a Class B digital device, pursuant to part 15 of the FCC rules. These limits are designed to provide reasonable protection against harmful interference in a residential installation. This shade generates, uses and can radiate radio-frequency energy. If this shade is not installed and used in accordance with the instructions, it may cause harmful interference to radio communications. However, there is no guarantee that interference will not occur in a particular installation. If this shade does cause harmful interference to radio or television reception, which can be determined by turning the shade off and on, correct the interference by one or more of the following measures:

Reorient or relocate the receiving antenna.
Increase separation between shade and receiver.

Connect equipment to an outlet on a circuit different from that to which the receiver is located.

Consult your dealer or an experienced radio/TV technician.

Any changes or modifications to the product that are not expressly approved by HT could void the user's authority to operate this shade. Use of a shielded interface cable is required to comply with the Class B limits of Part 15 of FCC rules. For more regulatory information, see the electronic user guide. HT shall not be liable for any direct, indirect, incidental, consequential, or other damage alleged in connection with the furnishing or use of this information.