

ROLLER SHADES

Standard Installation Instructions - April 2007

1) Mount the Brackets

If the clutch is on the right end of the shade, attach the brackets to the window frame, window molding, wall or ceiling, as shown below. If the clutch is on the left end of the shade, reverse the bracket positions, left for right.

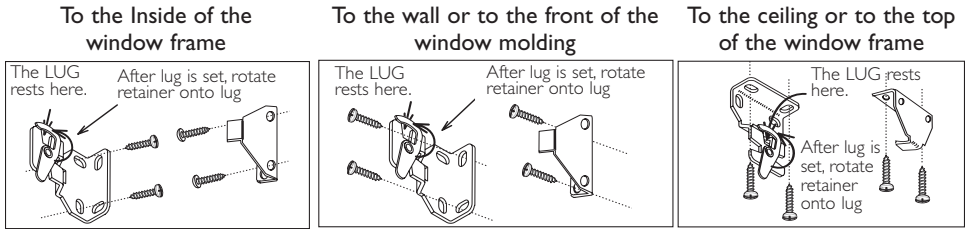

2) Install the Shade

- Push the clutch straight onto the blade of its bracket. The bottom of the clutch should always point straight down.
- Lower the lug of the end plug onto the "V" of its bracket. The roller should fit in the brackets securely, with just a little play. Rotate the riveted retainer portion to lock the lug in position.

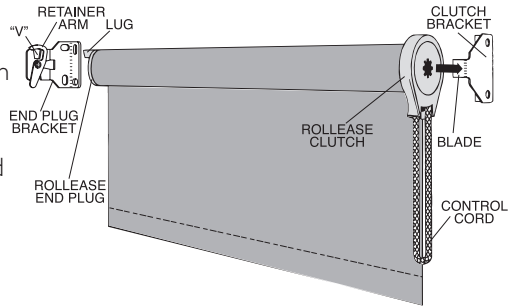

3) Install the Tension Device

The tension device reduces the hazards of strangulation and entanglement of young children and pets by limiting access to the control cord. Anchor the tension device that is attached to the shade's control cord to the window frame or wall so that young children or pets cannot pull the cord around their necks.



- Lower the shade.
- Hold the tension device upright so the Warning Tag hangs straight down as shown in diagram.
- Position the tension device on the window frame or the wall so that the tension device and control cord do not interfere with raising or lowering the shade. **The tension device should be installed without stretching or pulling down on the control cord. Stretching the cord will cause excessive wear. Do not twist or cross the control cord.** If using stop balls, position the tension device $1/4''$ higher to allow the stop ball to pass thru the tension device.
- Holding the tension device upright and in position as shown, insert and secure the screw through the hole. **The mounting screw must be secured into a solid surface or molly.**

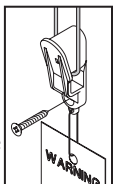

4) Use the Control Cord to Operate the Shade

Pulling gently on the cord in one direction raises the shade; pulling it in the other direction lowers it.

On shades where the fabric rolls against the window, the front cord does the raising.

On shades where the fabric rolls toward the room, the rear cord does the raising.

5) Attach Stops to a Control Cord that's made of Bead Chain

On metal bead chain, attach a metal stop ball that is at least 5/16" in diameter, so that it touches the mouth of the clutch when the shade is in the all-rolled-up position.

For metal or plastic bead chain, lower the shade to sill or floor height, and attach the appropriate metal stop or plastic connector next to the clutch, this prevents the shade from being lowered beyond that point.

Cassette System Installation

1) Mount the Brackets

Mount the brackets to the wall or window frame, with the outside brackets no further than 2" (5 cm) from the ends of the headrail. On wide shades, space the additional bracket(s) at equal intervals.

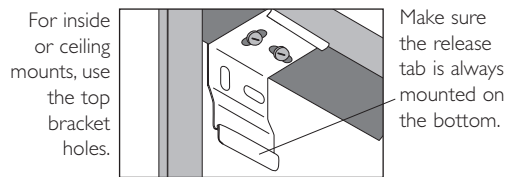
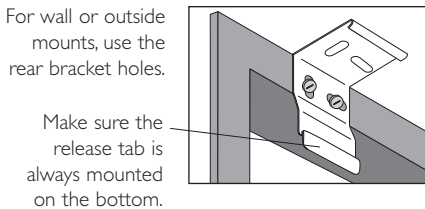
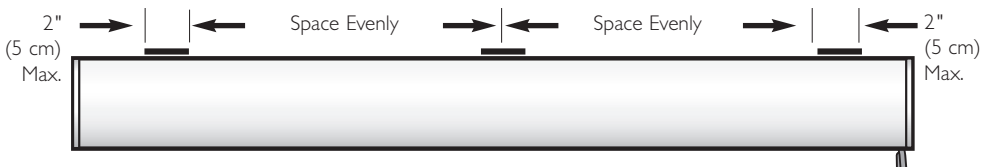

2) Mount the Headrail

Position the headrail with the front panel (A) resting on the top lip of all brackets. Push the bottom front of the headrail firmly backwards and toward the window until the lip on the rear of the headrail engages the bracket and snaps into place, (B) as shown.

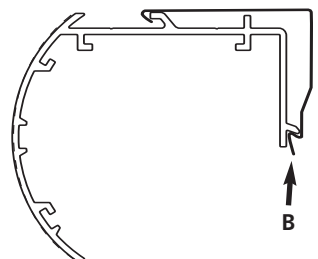
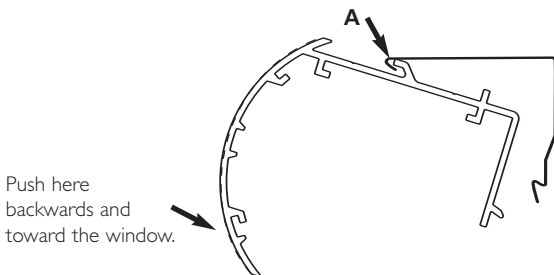

3) Install the Tension Device

The tension device reduces the hazards of strangulation and entanglement of young children or pets by limiting access to the control cord. Anchor the tension device that is attached to the shade's control cord to the window frame or wall so that young children or pets cannot pull the cord around their necks.

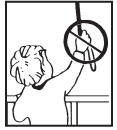

- a. Lower the shade.
- b. Hold the tension device upright so the warning tag hangs straight down as shown in diagram.
- c. Position the tension device on the window frame or the wall so that the tension device and control cord do not interfere with raising or lowering the shade. **The tension device should be installed without stretching or pulling down on the control cord. Stretching the cord will cause excessive wear. Do not twist or cross the control cord.**
- d. Holding the tension device upright, and in position, as shown, insert and secure the screw through the hole. **The mounting screw must be secured into a solid surface or molly.**

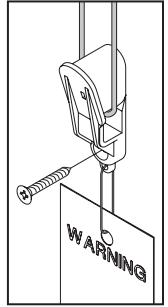

4) Operate the Shade

Operate the shade by pulling down on one side of the cord - one side of the cord raises the shade, the other side lowers the shade. Do not lift the bottom rail with your hands. Also, be careful not to place objects on the window sill that will interfere with operating the shade or cause it to hang unevenly.

5) To Remove a Shade

To remove a shade, from the bottom rear of the headrail insert a flathead screwdriver between the headrail and bracket. Gently twist the screwdriver and pry open the bracket to release the headrail. As you release the brackets, support the headrail to keep it from falling.

Fascia Panel Installation

1) Mount the Brackets

The open end of each bracket faces downward, as shown in the drawing below.

NOTE: If you have an inside mount and must use inside mount holes, you will have to drill your own holes in the side of the bracket. Use at least two screws per bracket, and make sure that the screw heads clear the clutch.

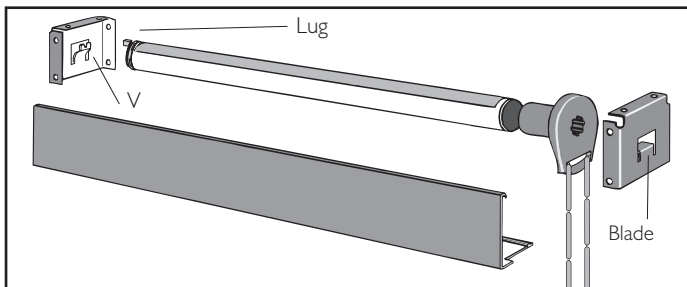

2) Install the Shade

Push the clutch straight onto the blade of its bracket. The bottom of the clutch should always point straight down, as shown in the illustration on page 3. Lower the lug of the end plug onto the V of its bracket. The roller should fit in the brackets securely, with just a little play.

ATTACH FASCIA PANEL

Attach the fascia by first hooking the top lip of the fascia panel onto the bracket as shown. Swing the bottom of the fascia panel towards the bracket and gently press at the bottom of the panel until the lip on the fascia engages and snaps lock to the bracket.

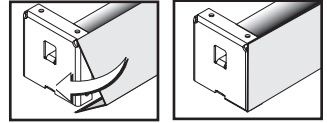

3) Attach Stops to Metal or Plastic Bead Chain

For plastic bead chain, use connector for top stop and attach another connector for lower stop. For metal bead chain, attach a metal stop ball at least 5/16" (8 mm) in diameter so that it touches the clutch when the shade is rolled all the way up. For both kinds of bead chain, lower the shade to sill or floor height, and snap the appropriate metal stop or plastic connector on the opposite side from the stop, so that the shade cannot be lowered beyond that point.

4) Install the Tension Device

The tension device reduces the hazards of strangulation and entanglement of young children and pets by limiting access to the control cord. Anchor the tension device that is attached to the shades control cord or bead chain to the window frame or wall so that young children or pets cannot pull the cord or bead chain around their necks.

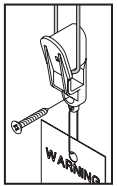
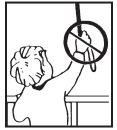

- Lower the shade.
- Hold the tension device upright so the warning tag hangs straight down as shown in diagram.
- Position the tension device on the window frame or the wall so that the tension device and control cord do not interfere with raising or lowering the shade.

The tension device should be installed without stretching or pulling down on the control cord. Stretching the cord will cause excessive wear. Do not twist or cross the control cord. If using stop balls on bead chain, position the tension device 1/4" higher to allow the stop ball to pass thru the tension device.

- Holding the tension device upright, and in position, as shown, insert and secure the screw through the hole. **The mounting screw must be secured into a solid surface or molly.**

5) Use the Control Cord or Bead Chain to Operate the Shade

Pulling gently on one side of the control cord or bead chain raises the shade; pulling down on the other side lowers it.